

# Adventure Control User Manual

v1.1

## WARNING STRONG MAGNETS INSIDE WARNING

Do not place near pacemakers or other devices/objects sensitive to magnetic field

### 1. Description

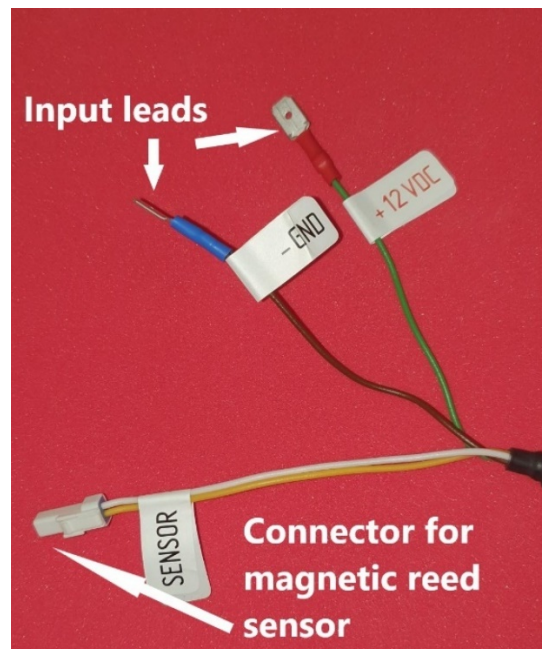
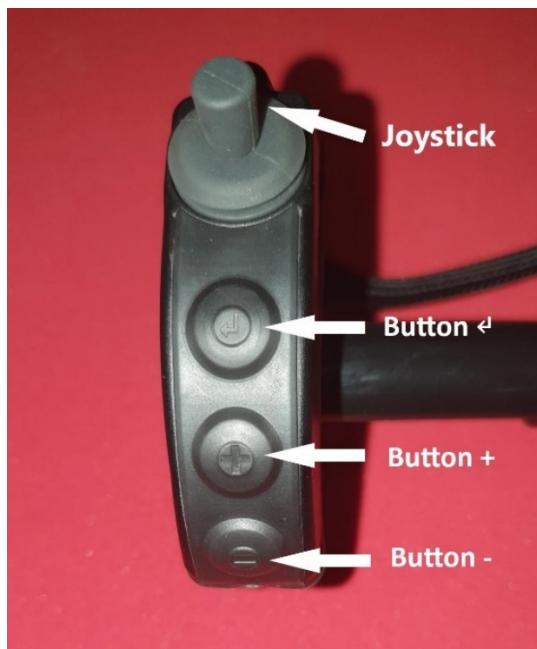

### 2. Mounting

- 2.1. Adventure Control („Adv Ctrl“) is designed for permanent installation on **22mm** diameter handlebar.
- 2.2. Create adequate space on handlebar so that Adv Ctrl fits between handlebar grip and stock instrument cluster.
- 2.3. Depending on your riding style (mostly on the foot pegs / sitting down) rotate Adv Ctrl to find appropriate angle to have its control elements within reach of your thumb.
- 2.4. Use the provided bracket and M4 screws to secure Adv Ctrl on the handlebar. Do not use excessive torque, which could break the bracket or Adv Ctrl housing. Required tool (not provided): 2,5mm HEX key.

2.5. The included retaining bracket is not ambidextrous. Correct orientation:



2.6. Secure the Adv Ctrl cable assembly on the handlebar by e.g. zip ties. Do NOT excessively strain the cable:

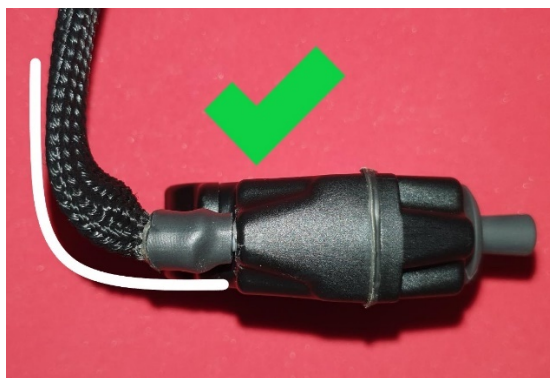

2.7. Connect Adv Ctrl input leads with motorcycle electrical system (**standard 12VDC nominal voltage is required**). Positive terminal is marked as „12VDC“, negative as „GND“. Always connect “GND” first. Hint: apply dielectric grease (battery contacts fat) on the terminals prior to installation to ensure good contact and prevent oxidation.

2.8. There are 6,3mm Faston style tabs on the input leads.

2.9. Adv Ctrl does not have its own power backup (battery). Therefore, it is recommended to connect Adv Ctrl to the motorcycle auxiliary power socket that is always powered, otherwise Adv Ctrl will shut down when ignition will be in OFF position. Alternatively, Adv Ctrl can be connected directly to the onboard motorcycle battery, PROVIDED a fuse box with no more than 5V fuse is installed between Adv Ctrl input leads and the battery. To connect Adv Ctrl to the motorcycle battery, you can use Carpe Battery Extension Cable (sold separately).

2.10. Should you choose to use Adv Ctrl magnetic sensor reading capability, connect standard magnetic reed sensor (2 wire) to the connector marked as „SENSOR“. Connecting SENSOR is only required, in case you plan to use front wheel revolutions readings and it is **not required for normal Adv Ctrl operation**. The SENSOR connection is polarity ignorant. **DO NOT connect the SENSOR with stock front wheel sensor on your motorcycle** or Adv Ctrl will be destroyed (different voltage levels). In other words, except connecting the 12VDC and GND terminals, Adv Ctrl **MUST NOT** be connected to your motorcycle electrical system/electronics through the SENSOR.

### 3. Use

- 3.1. Adv Ctrl is not operational as a self-standing device. It requires installation of the companion software – Carpe Control app and enabling certain services to run on your Android powered smart device.
- 3.2. In order to work properly, Adv Ctrl **MUST** be connected to your Android powered smart device via the companion software – Carpe Control app (do not make manual Bluetooth connection).

#### 3.3. First connection

- 3.3.1. Download and install Carpe Control app from Play Store (pre-installed on CI Pad). If already installed, update it to the latest version (check for updates on Play Store in case of other than CI Pad device / check for updates in Carpe Manager in case of CI Pad). **DO NOT install Play Store version of Carpe Control app on CI Pad.**
- 3.3.2. Grant all permissions requested by Carpe Control app during installation. If you deny any of the requested permissions, Carpe Control app (and subsequently Adv Ctrl) will not work.
- 3.3.3. Ensure Adv Ctrl is connected to power. Then open Carpe Control app on your Android powered device and follow on-screen instructions. Your Android powered device must be within Bluetooth range, to complete the process.
- 3.3.4. Once the first connection is completed, a bond is created between your Android powered device and Adv Ctrl and you can start using Adv Ctrl to control supported applications (see Carpe website for details).
- 3.3.5. Adv Ctrl may be bonded to more than 1 Android powered device. **WARNING** – make sure only one of the previously bonded devices has active Bluetooth, when both are within range of Adv Ctrl – it is not possible to control to which device Adv Ctrl would connect (first come first serve in terms of Bluetooth connection routine). If you must keep Bluetooth active on both previously bonded devices for any reason, you will need to delete connection to Adv Ctrl on the one, that you presently do not intent to use together with Adv Ctrl (please see Section 3.5).

#### 3.4. Subsequent connections

- 3.4.1. Following the initial connection described in Section 3.2, Adv Ctrl will connect automatically when a bonded device is detected. The connection is almost instantaneous under normal conditions.
- 3.4.2. In order to detect the presence of a bonded device: (A) Adv Ctrl must be powered and not in idle mode, (B) Bluetooth must be enabled and within range on the bonded device.
- 3.4.3. If Adv Ctrl is in idle mode **while being connected to power**, pressing Button  will activate it. Adv Ctrl activates automatically when power is cycled, i.e. when it is newly connected to power and voltage is detected on its input leads (in case you connected it to your motorcycle ignition operated auxiliary power outlet, this requires putting the ignition to ON position).

### 3.5. Unpairing

3.5.1. Pairing relationship between your Android powered device and Adv Ctrl can be deleted either manually in the device Bluetooth manager or directly via the function in Carpe Control app – Configuration – Delete controller.

### 3.6. Initialization routine explained (automatic)

3.6.1. Active mode is indicated by blue LED blink on Button ↵ and green LED on Button + and Button – (Adv Ctrl enters active mode when newly connected to power or revived from idle mode by pressing Button ↵ while being connected to power).

3.6.2. Initialization routine is started when Adv Ctrl enters the active mode, and it includes checking voltage on input and calibration of the joystick. From practical perspective, the initialization routine is almost instant, and its completion is indicated by displaying LED color code representing voltage on input (see Section 4.4.5).

3.6.3. DO NOT operate the joystick during initialization procedure or the joystick will not be calibrated properly (hint: just wait couple seconds until you see steady color on all buttons).

3.6.4. As soon as the initialization routine is complete, Adv Ctrl is ready to use (as mentioned above - from practical perspective Adv Ctrl is ready to be used almost instantaneously after connecting to power).

3.6.5. When Adv Ctrl is active **and connected to previously bonded Android powered device**, LED color scheme changes to selected backlight color (white in default, can be modified by the user) – normally 1 second following initialization.

3.6.6. Pressing a button is indicated by increased LED intensity on the button being pressed.

3.6.7. **DO NOT** use button combos (pressing more than one button at the same time) during normal operation.

### 3.7. Power saving features

3.7.1. Adv Ctrl has advance power saving feature – idle mode. When in idle mode, it only consumes 2mA of energy and can stay connected to your motorcycle battery for extended periods of time without draining it.

3.7.2. Idle mode is indicated by “breathing” red LED on Button ↵. To wake up Adv Ctrl from idle, press Button ↵, which resumes normal operation (following initialization procedure – see Section 3.6).

3.7.3. Idle mode is triggered by any of the following events:

3.7.3.1. manually in hardware set-up mode. See Section 4.3.2.1;

3.7.3.2. automatically – triggered by input voltage drop below 13V with no user input for more than 60 seconds (engine not running) – you can keep using Adv Ctrl with engine off, as long as you press a button or move joystick once per minute (e.g. when planning route with engine off);

3.7.3.3. automatically – triggered when Adv Ctrl is not in use (no user inputs on the buttons or joystick and no input from SENSOR (SENSOR not connected or bike stationary)) for more than 120 minutes. In this case, idle mode is independent from voltage level, i.e. after 2 hours without using Adv Ctrl idle mode is triggered even on bikes with LiFePo batteries, which have higher nominal voltage than 13V.

#### 4. Setting up Adv Ctrl

- 4.1. None of the steps described below in this Section are required for normal operation – all is ready out of the box.
- 4.2. There is a host of adjustment possibilities to tweak Adv Ctrl to your liking. Some settings are available through the Carpe Control app only, some can be also accessed directly on Adv Ctrl.

#### 4.3. Hardware side settings

- 4.3.1. Adv Ctrl side set-up mode is entered by simultaneously pressing Button ↵ and Button - . Set-up mode is indicated by blue color on all 3 LEDs (regardless of backlight color pre-set).
- 4.3.2. When Adv Ctrl side set-up mode is entered:
  - 4.3.2.1. Button ↵ : enter idle mode. To revive Adv Ctrl from idle press Button ↵ again, following which Adv Ctrl will go directly to normal operation (set-up mode is exited automatically). Idle mode is indicated by breathing red LED on Button ↵;
  - 4.3.2.2. Button + : show input voltage level for 2 seconds (see Section 4.4.6 for details). After that at all LEDs go back to blue (= set-up mode);
  - 4.3.2.3. Button - : exit Setup Mode;
  - 4.3.2.4. Joystick Up / Down: increase/decrease backlight intensity. Newly selected LED intensity is pre-viewed in selected back-light color for 2 seconds, following which the LEDs go back to blue (= set-up mode). It is not recommended to use more than 50% brightness in locations with high temperatures or overheating might occur;
  - 4.3.2.5. Joystick Left / Right: toggle backlight color. Available colors: Red, Green, Blue, White, Orange (the Adv Ctrl semi-transparent housing has a color tint of its own, so the selected color might not be exact representation of the pre-set. This applies especially to “White”). When a selection is made, the newly selected back-light color is pre-viewed for 2 seconds, following which the LEDs go back to blue (= set-up mode).

#### 4.4. LED Color Codes

- 4.4.1. Selected back-light color on all LEDs – connected to Bluetooth, ready for operation (default color is White – sort of 😊);
- 4.4.2. Rapid blue blink on Button ↵: Bluetooth pairing;
- 4.4.3. Rapid blue blink on Button ↵ plus green/red combination on other LEDs: initialization procedure running/Bluetooth connection lost;
- 4.4.4. steady blue on all LEDs: Adv Ctrl hardware set-up mode (too bad, if you selected blue as your back-light color – it will be deceiving 😊);
- 4.4.5. red „breathing“ LED on Button ↵ : connected to power, idle mode.

#### 4.4.6. Battery Level (Input Voltage) Indication

Voltage level on Adv Ctrl input is indicated by different LED color codes:

- 4.4.6.1. 3 Green LEDs - Voltage is above 13V;
- 4.4.6.2. 2 Green LEDs - Voltage between 12.5V and 13V;
- 4.4.6.3. 1 Green LED - Voltage is between 12V and 12.5V;
- 4.4.6.4. 3 Red LEDs - Voltage is between 11.5V and 12V;
- 4.4.6.5. 2 Red LEDs - Voltage is between 11V and 11.5V;
- 4.4.6.6. 1 Red LED - Voltage is bellow 11V.

This feature can be used to check **approximate** voltage level of the motorcycle battery **with engine powered down**. What it checks exactly is voltage level on the Adv Ctrl input leads, i.e. this voltage might be affected by various variables on your bike and, therefore, might not exactly correspond to the motorcycle battery level.

#### 4.5. Carpe Control app settings

4.5.1. Additional settings are available in the Carpe Control app under:

- 4.5.1.1. CONFIGURE > JOYSTICK SENSIBILITY. Sensitivity of the joystick can be increased or decreased. Increasing sensitivity is generally not recommended, especially on motorcycles producing significant vibrations. On the contrary, reducing sensitivity can mitigate issues associated with high-vibration environment on some bikes;
- 4.5.1.2. CONFIGURE > BUTTON BACKLIGHT. Allows to set back-light color and intensity. It is not recommended to use more than 50% brightness in locations with high temperatures or overheating might occur.

4.5.2. Under Configure tab in Carpe Control app, you can select to have input voltage displayed on the app main screen.

4.6. LEDs can also be controlled in the HUD (long press Button ↵ during normal operation to access HUD).

#### 5. Operating considerations

- 5.1. Never exceed operating parameters stated in Section 6 or Adv Ctrl will get damaged or destroyed.
- 5.2. Ensure correct polarity of the Adv Ctrl input leads.

5.3. Do not pull on the Adv Ctrl cable assembly:

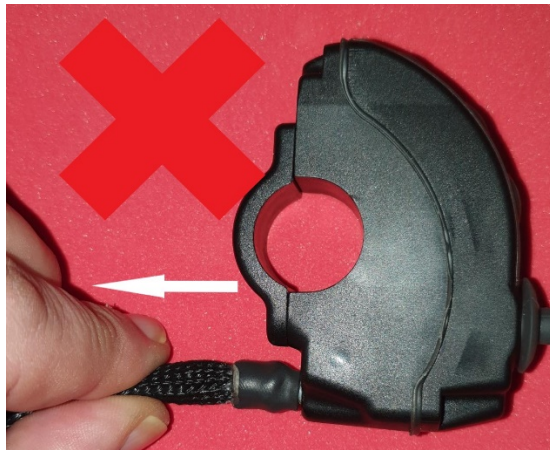

5.4. Do not strain the Adv Ctrl cable assembly:

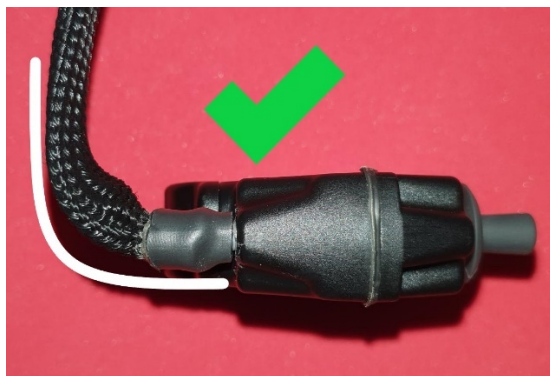

5.5. When disconnecting the Adv Ctrl cable assembly from your motorcycle or when disconnecting the magnetic sensor, never pull wires:

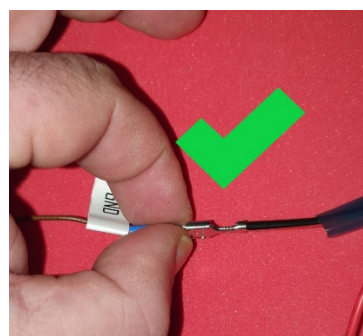
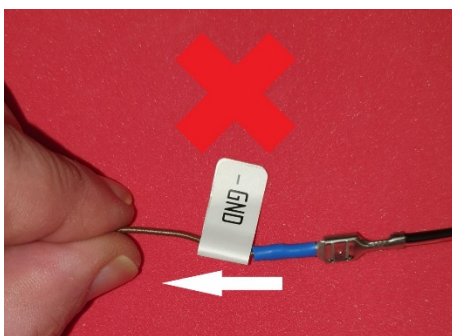

5.6. Check all screws on Adv Ctrl enclosure after every ride. If they come loose, apply mild thread-locking agent and re-torque them as required. Do not apply excessive torque or damage to the Adv Ctrl enclosure will occur. Max torque is 0,08Nm /8Ncm (rule of thumb – the seal between the plastic parts needs to be squashed just a little). Loose screws will compromise watertightness of the enclosure. Water ingress will destroy Adv Ctrl. Hint: **thread-locking agent was applied during production to all screws holding the Adv Ctrl enclosure together, so they do not need to be re-torqued under normal operating conditions.**

- 5.7. Check that Adv Ctrl enclosure is intact after every ride, especially after a crash. If cracks appear in the housing, it must be replaced to prevent water ingress and destruction of Adv Ctrl electronics. Adv Ctrl enclosure cannot be replaced by you and must be sent to Carpe for replacement (contact Carpe support team before you do that).
- 5.8. Exceeding upper storage temperature range will result in damage to the Adv Ctrl electronics and de-magnetization of NdFeB magnets used for joystick centering and operation.
- 5.9. Exceeding upper operating temperature range will result in overheating. When overheating occurs, Adv Ctrl will resume its normal operation after it cools down to normal operating temperature (unless the heat exceeded the operating parameters to such degree to inflict permanent damage).
- 5.10. It is recommended not to leave Adv Ctrl exposed to direct sunshine in high-temperature locations. When parking motorcycle in shade is not an option, cover Adv Ctrl with a piece of cloth to prevent overheating. Under normal operating conditions, heat is not an issue when moving (airflow will ensure sufficient heat dissipation). However, in high temperature locations it is not recommended to use more than 50% brightness for buttons' back-light, to reduce heat generated by Adv Ctrl internal LED driver.
- 5.11. DO NOT apply jet water on Adv Ctrl (e.g. when cleaning your motorcycle, avoid hitting Adv Ctrl with direct stream from WAP or other jet water system). When installing Adv Ctrl on your motorcycle, do not place it into direct airstream – high speed riding in rain can create similar conditions like jet water.

## 6. Specifications

- Operating voltage: 10-15V DC.
- Average power consumption when in use: 40mA@12V (BT Connected, Wheel Sensor being used and 3 LEDs at max brightness).
- Average power consumption when idle mode: 2mA.
- Water and dust resistant. Official IP rating has not been done, but Adv Ctrl is designed to survive on a motorcycle in any weather conditions (subject to operating limitations stated in Section 5).
- Operating temperature: minus 15 to 60 °C (the upper range includes heat accumulated in the Adv Ctrl enclosure by external sources, such as the Sun).
- Storage temperature: minus 15 to 80°C (the upper range includes heat accumulated in the Adv Ctrl enclosure by external sources, such as the Sun).
- Control elements:
  - 1x HALL joystick;
  - 3x mechanical pushbutton.
- Maximum operating force on control elements: 2kg.
- Normal operating force on control elements: 0,5kg.
- User feedback system: 3xRGB LED.
- Maximum SENSOR frequency: 40Hz (that equals to more than 300km/h with 21-inch wheel).



- Connectors:
  - 6,3mm Faston tab on power input;
  - JST 02R-JWPF-VSLE style connector for SENSOR.
- Dimensions WxLxH: 22x77x30 (height above handlebar excluding joystick)

## 7. Disclaimer

- 7.1. Unless explicitly stated for a specific Carpe Iter item (Adv Ctrl, CI Pad, Holder, their accessories, brackets and other Carpe Iter equipment) (“**Item**”) otherwise, no testing or homologation procedures were taken to ensure compliance with regulations associated with using the Items in regular traffic – on the streets. Use at your own risk.
- 7.2. Make sure that Items with sharp edges are positioned so that the sharp edge does not face the rider. Always dismount Items, which you are not currently using – especially empty holders and brackets (which may form a sharp edge when empty).
- 7.3. Even if the Items are mounted to your vehicle properly, you might suffer an injury to your body (bruises, tearing, fractures, etc.) or damage to your gear (tearing, breakage, etc.) especially in case of an accident (e.g. dismounting your vehicle in other than standard way).
- 7.4. Manuals and use instructions are only provided in electronic form and can be viewed and/or downloaded on our website. Manuals and instructions for use shall not be provided in printed form.
- 7.5. Our manuals and instructions for use assume casual experience with smart devices (such as smartphones) and basic manual dexterity. In case of doubt, installation of Items on a vehicle must be performed by a specialized workshop.
- 7.6. Manuals and instructions for use, as well as technical support are only provided in English.

## 8. Warranty

- 8.1. Carpe provides world-wide warranty in the scope set forth below for defects, which exist upon delivery of an Item to the shipping address provided by you upon purchase and which shall manifest within the period of 2 year as of the date of the original purchase, if you are a consumer, and 1 year as of the date of the original purchase, if you are a business (you provided business identification number or VAT number upon purchase). This warranty does not apply to software and batteries (see below). The date of dispatch of an Item to your shipping address is deemed to represent the date of original purchase.
- 8.2. Limited 6 months warranty is provided for batteries included in an Item or, as the case may be, sold separately. In the course of this limited battery warranty, we guarantee that the battery will retain at least 60% of its nominal capacity. No warranty is provided for batteries beyond the period of 6 months following the date of original purchase. Warranty for batteries is subject to adhering to the use instructions set forth above.
- 8.3. Our warranty only covers defects that preclude the use of an Item for its purpose. In view of the intended purpose of use of the Items, our warranty does not cover in particular: defects of cosmetic nature, such as discoloration, paint fading, rusting that does not hinder the use, etc.
- 8.4. Our warranty is subject to adhering to manuals and use instructions published on our website or stated above in this manual for individual Items. Our warranty does not cover defects occurring due to misuse of Items and lack of their maintenance. Our warranty does not cover usual wear and tear.

- 8.5. No warranty is provided for software.
- 8.6. No warranty is provided for defects occurring as a result of outside forces (abrasion, shock, water, pressure, vibration, UV light, etc.).
- 8.7. Plastic and rubber parts of Items are considered expendable material.
- 8.8. Item, in respect of which our defect warranty is claimed, including a detailed written description of the defect, must be delivered for inspection to the address of our seat or other address published for that purpose on our website. Any and all cost associated with the delivery, including without limitation fees and other duties incurred by us in association with re-importing the Items into EU, will be borne by you and we will be entitled to request the respective reimbursement to be credited to our bank account before your warranty claim is processed.
- 8.9. We shall be free to choose any of the following actions to satisfy your warranty claim:
  - 8.9.1. repair, if repair is economical;
  - 8.9.2. adequate monetary compensation;
  - 8.9.3. replacement of the defective Item.
- 8.10. We may always choose to replace a defective Item instead of carrying out a repair or providing monetary compensation.
- 8.11. your warranty claim shall be reviewed and responded to within 30 days following the delivery of the defective Items our address provided by us for that purpose.
- 8.12. It is strongly recommended that you contact us by email before dispatching an Item, in respect of which you plan to claim warranty. We might choose to satisfy your claim without the need to return the defective Item, which will save time and shipping cost.